

Installation Guidelines
Spectrian MC180A
Multicarrier Power Amplifier



The Power in Wireless Communications

Revision 1.3

November 1996

Spectrian Corporation

MC180A Multicarrier Power Amplifier Installation Guide.
Revision 1.2, August 1996.
Revision 1.3, November 1996

Document Number: 96001008
Copyright © 1996 Spectrian Corporation
All Rights Reserved.
Printed in USA.

This document is released for the purpose of installing and operating the MC180A and is subject to change without notice. This document may not be reproduced without written permission from Spectrian Corporation.

Trademarks:

Spectrian and Spectrian logo are registered trademarks of Spectrian Corporation.

Additional service information may be obtained by contacting:





Spectrian Corporate office

350 Java St.
Sunnyvale, CA 92686
Telephone: (408) 745-5400 Facsimile: (408) 541-0263

Service Provider Market office

3080 Enterprise Street
Brea, CA 92621
Telephone: (714) 993-0802 Facsimile: (714) 993-1619

ATTENTION!**USERS OF THE MC180A SHOULD READ THESE IMPORTANT SAFETY INSTRUCTIONS BEFORE OPERATING THIS EQUIPMENT:**

-  **Warning:** The MC180A power amplifier transmits very high power levels at radio frequencies. Severe radiation burns can occur if recommended safety precautions are not strictly observed.
-  **Warning:** Exposing the human eye to high levels of radio-frequency radiation may result in the formation of cataracts. Do not operate exposed circuitry or radiating elements with personnel in close proximity to the radiating source.
-  **Warning:** To avoid injury, installers, technicians, and maintenance personnel must follow Spectrian's recommended procedures and observe all safety precautions.
-  **Important:** Always disconnect power to the MC180A amplifier before performing procedures that do not require power. For those procedures that do require power, be extremely cautious in handling test leads, tools, and equipment near live circuits.
-  **Important:** Never reach into an enclosure for the purpose of servicing or adjusting except in the presence of a person who can render aid.

Preface

How to Use This Guide

This instruction guide has been arranged so that each chapter builds upon the information provided in prior chapters. Because of this structure, the best way to derive the greatest benefit from this guide is to read it through from the beginning. The guide is arranged so that frequently-used information is located near the front of the guide and infrequently-used information, such as installation instructions and service information, is located at the back of the guide. Appendix A contains detailed reference information about your specific product configuration.

Instructions for Installers

Information about site preparation is provided in Chapter 3. Information about assembly of the MC180A is provided in Chapter 4. Hardware and other information specific to your configuration is furnished in Appendix A.

Instructions for Operators

Operating instructions and instructions for performing a verification check are provided in Chapter 5. Diagnostic checks and repair instructions are provided in Chapter 6. Appendix A contains information about fault indicators and alarms.

How this document is organized

This guide is organized as follows:

Chapter 1. Introduction, describes the MC180A multi-channel power amplifier.

Chapter 2. Receipt, discusses steps to be taken to receive and inventory, and inspect the MC180A prior to assembly.

Chapter 3. Installation, explains how to prepare the site for installation, including connecting the site DC voltage, RF cabling, user interface cables. and installation.

Chapter 4. Operation, explains how to verify that the MC180A is performing after completing installation.

Chapter 5. Diagnosis and Repair, explains how to diagnose problems using the fault indicators and alarm reporting functions of the MC180A.

Appendix A. Configuration Information, provides addition information about your particular MC180A product configuration, including product specifications, isometric diagrams and connector pinouts.

Table of Contents

Preface

How to use this guide	iv
How this document is organized	v

Chapter 1

Introduction

1.1 Introduction to the MC180A.....	1
1.2 Safety information.....	1

Chapter 2

Receipt

2.1 Inventory.....	3
2.2 Safety equipment, tools and equipment	3
2.3 Unpacking.....	4
2.4 Receiving inspection	4
2.5 Repackaging for return shipment	5

Chapter 3

Installation

3.1 Introduction.....	6
3.2 Hardware and site considerations	6
3.3 Environmental considerations	7

Table of Contents

3.4	Safety equipment, tools and materials.....	8
3.5	MC180A rack installation	8
3.6	MC180A unit address.....	9
3.7	Supplied DC voltage	10
3.8	Ground wire installation	10
3.9	DC voltage wire installation.....	11
3.10	RF cabling	12
3.10.1	Input RF cable installation.....	12
3.10.2	Output RF cable installation.....	12
3.11	Customer interface.....	13
3.11.1	RS-485/Alarm interface cable installation.....	13
3.11.2	Alarm output interface cable installation.....	14
Chapter 4		
Operation		
4.1	Introduction.....	15
4.2	Safety information.....	15
4.3	Tools.....	16
4.4	Start up and verification	16

Chapter 5

Diagnosis and repair

5.1	Introduction.....	19
5.2	Safety information.....	19
5.3	Fault status.....	20
5.3.1	Fault management.....	20
5.3.2	Fault classification.....	20
5.3.3	Responses to faults.....	21
5.3.4	Automatic fault resets.....	21
5.3.5	Manual fault resets.....	22
5.4	LED indicators.....	22
5.5	Using LED indicators to diagnose and remedy faults.....	22
5.6	Using status codes to diagnose and remedy faults.....	23
5.7	MC180A replacement.....	24
	Appendix A. Configuration Information.....	25

Chapter 1

Introduction

1.1 Introduction to the MC180A

The MC180A is built for ease of installation and operation. The MC180A produces 30 watts of average output power, using modular subassemblies to provide the necessary DC voltage, RF signal paths, and control circuits. Spectrian has carefully selected materials and employed years of amplifier design experience to produce a low cost product that is durable, reliable, and facilitates speed and ease of both installation and operation. By simplifying the basic system architecture and incorporating high efficiency circuit design, Spectrian's latest design efforts have successfully translated customer's hardware needs into an amplifier that is ready to be deployed throughout the world.

Personnel involved with receipt, inspection, and other material handling should take time to read the guidelines given in Chapter 2. The MC180A is designed to be installed by trained and qualified technicians. Installers should take time to read and understand Chapter 3, *Hardware*, prior to attempting to install the MC180A at the site location. There are some basic site preparation steps that should be done prior to installing the system.

1.2 Safety Information

Always use the recommended safety equipment. Please read and understand instructions and warnings before unpacking or lifting the MC180A. When packaged for shipping, the MC180A is heavy and may be unevenly balanced. To avoid injuries or damage, use care and obtain assistance when lifting a crated MC180A.

Please read and understand all instructions and warnings before handling a MC180A. Always use the recommended safety equipment.

 **Important: Do not perform any unauthorized modification to the MC180A. Modifications without the written consent of Spectrian will void the product warranty.**

Spectrian places protective seals over the MC180A cover screws. If the seals are disturbed without the written consent of Spectrian, the product warranty shall be void.

 **WARNING: Do not install or operate the MC180A in the presence of flammable gases or fumes.**

Chapter 2

Receipt

2.1 Inventory

Upon receipt of the MC180A remove the packing lists, installation kit, and other documents attached to the shipping container. Examine shipping documents to make certain that they agree with your copy of the order. If there is a discrepancy between the order and the items or quantity shipped, contact your Spectrian representative listed in the front of this instruction guide. Check the packing list and verify that all necessary equipment has been delivered, and that the parts are undamaged. If any evidence of shipping damage is noted, notify the proper delivery agency before continuing.



Note: If the container or contents appear to be damaged, you must contact the carrier without delay and file a damage claim. If shipping damage occurred, the carrier may wish to have a claims agent present when the MC180A is unpacked and inspected. You must also notify your Spectrian representative and advise that the MC180A was damaged during shipment.

2.2 Safety equipment, tools, and materials

Uncrating, inspecting, and preparing the MC180A for site installation will require some tools and materials not included in the shipment. Use of the following materials is suggested to perform these tasks.

Safety Equipment:

- Safety glasses
- Steel-toe shoes
- Work gloves
- Back-support belt

Tools:

- Box knife
- Straight-blade screwdriver
- Pen or pencil
- Pair of large scissors
- Strap cutter
- Inspection flashlight or lamp

Other Materials:

- A copy of the purchase order
- A copy of the packing list

2.3 Unpacking

If the shipping container was received in good order, you may unpack the MC180A. You may wish to unpack and inspect the MC180A on your receiving dock, or you may wish to transport the MC180A to the installation site and unpack it there. Make certain that you have assembled tools, materials, and safety equipment before beginning work.

- a). Begin by opening the shipping containers and inspecting the contents. Using the required safety equipment and tools, carefully cut the metal and/or nylon straps that surround the shipping container. When using a box knife or scissors, take care not to damage the contents of the box. Take care to avoid scratching the cabinet finish.
- b). Do not remove the ESD protective wrapping that surrounds the cabinet, unless wearing an ESD protective wrist strap. If possible remove this material by unwrapping the MC180A by hand, rather than cutting this material with scissors or knives. It is advised that the protective wrapping is not removed until installation.
- c). Remove spacers, packing inserts, protective coverings, plastic bags, and other shipping materials from the outside of the MC180A. Avoid using knives or scissors to perform this task.
- d). Carefully collect and dispose of the packing materials. Many of the packing materials used by Spectrian are suitable for recycling and need not contribute to landfills.

The MC180A is now ready for receiving inspection.

2.4 Receiving inspection

While inspecting the unpacked MC180A compare the quantity and labeling of each module with shipping documents and the purchase order. If there is an unresolved discrepancy between the order and the items received, contact your Spectrian representative.

Inspect the MC180A exterior for evidence of shipping damage. Metal surfaces should not be dented or scratched. Panels, handles, screws, and indicators should appear undamaged and properly aligned.

Connectors should be tightly affixed to the cabinet, with no visible dents or distortion.

 **Note:** If you discovered damage during inspection, contact the shipper and Spectrian at once. The shipper will furnish instructions on how to document the discovered damage. Spectrian will arrange to promptly ship replacement parts.

2.5 Repackaging for return shipment

Detailed repackaging instructions are beyond the scope of this document. If it becomes necessary to repackage parts of the MC180A for return shipment to the factory, contact the Spectrian service department for detailed instructions. Contact addresses and phone numbers are provided on page i of this document.

If the MC180A is acceptable, it is ready to be moved to its permanent location for installation.

Chapter 3

Installation

3.1 Introduction

This chapter provides instructions for doing site preparation and hardware installation. The MC180A features RF input and output connectors, a DC voltage input receptacle, a RS-485 serial interface connector, and a remote alarms interface connector. Specific connector and pinout information for your MC180A configuration is provided in Appendix A.

Local building and fire codes govern the manner in which some site preparation and installation tasks are performed. If there questions about whether site installation conforms to local building codes, Spectrian recommends that you consult your local building inspector or a licensed engineer.

3.2 Hardware and site considerations

Weight: The MC180A must be installed into an appropriately sized rack capable of supporting the unit, and located on a floor or surface capable of supporting the combined weight of the rack, the MC180A, and the installer or technician. Appendix A includes specific information regarding the weight of your MC180A configuration.

Clearance: When operating, the MC180A requires clearance in front of the cabinet for unrestricted airflow, plus a minimum of 8 inches behind the MC180A to exhaust hot air. Some additional consideration should be made to accommodate the routing of the RF input cable located on the front panel. Appendix A includes specific information regarding the physical dimensions and diagrams for your MC180A configuration.

Floor: If you intend to use a floor covering under the MC180A, avoid combustible materials, industrial carpeting, or materials that will permit generation of electrostatic charges.

Illumination: The MC180A is designed to be installed and serviced under normal workroom lighting. During installation, room lighting

must be bright enough to allow reading instructions and inspection of modules, but not so bright as to interfere with viewing the status LED indicators on the front panel. The MC180A should be oriented or shielded so that direct sunlight does not fall upon the front panel.

Fire Protection: Spectrian recommends that the MC180A installation site be equipped with smoke detectors and an automatic fire-extinguishing system. In addition, for personnel safety, the site should be equipped with a portable halogen or CO₂ fire extinguisher.

Lightning Protection: Spectrian recommends that when used in locations subject to lightning discharge, all power, RF, and signal lines that connect to the MC180A must be protected by approved lightning arrestors. Your local fire or safety codes will determine the type of lightning protection required.

3.3 Environmental considerations

 **Note:** MC180A Product Specifications for your particular configuration are provided in Appendix A.

Temperature: The MC180A will operate reliably when exposed to normal cell site temperature variations.

Humidity: The MC180A will operate reliably within 5 - 95 percent relative humidity (noncondensing).

Altitude: The MC180A may be installed between 1600 ft below sea level (-500 m) to 13,000 ft (4000 m) above sea level.

 **Note:** When installing the MC180A above 5000 ft (1542 m), derate the maximum operating temperature by 2° C per 1000 ft (304 m) above 5000 ft.

Ventilation: The MC180A requires unrestricted airflow around the MC180A. The site must be ventilated or air-conditioned so that ventilation air does not exceed 50° Celsius.

Ambient air quality: The MC180A should be installed in a location that is free of airborne dust and toxic or corrosive fumes.

Vibration: The MC180A tolerates moderate levels of vibration and ambient noise. The MC180A should not be installed in a location

subject to mechanical shocks or vibrations conducted from nearby mechanical equipment.

Noise: The MC180A generates fan noise below 65 dBA during operation and no additional acoustic treatment of the site is needed.

3.4 Safety equipment, tools and materials

The following safety equipment, tools, and materials are recommended to perform installation tasks.

Safety Equipment:

- Safety glasses
- Back-support belt
- Work gloves

Tools:

- Straight-blade screwdriver
- Adjustable wrench
- Volt-Ohmmeter (VOM) or continuity tester
- Phillips-head screwdriver
- Inspection lamp or flashlight
- ESD protective wrist strap

Materials:

- Pressurized can of spray-on contact cleaner
- Rack-mounting hardware and fasteners
- Power, RF, and signal cables
- Crimp-on circular lugs
- 10 AWG solid copper ground wire

3.5 MC180A rack installation

The MC180A complies with commercial requirements for rack-mounted equipment. The assembly outline dimensions are provided in Appendix A. The MC180A assembly is labeled with the part and serial numbers, using standard EIA part identification, date code, and serializing methods. The MC180A is preassembled and contains all internal wiring for DC power, user interface, and RF signals. Brushless DC cooling fans are mounted within the MC180A. Cooling air is drawn through grille openings in the front of the module and discharged through the rear.

 **Note:** The MC180A contains no user-serviceable components.

 **Caution:** The MC180A is not delivered with side rails. The customer's rack must provide mechanical support for the weight of the MC180A.

 **Warning:** The MC180A is heavy. Use caution when lifting.

Make certain that adequate space within the rack enclosure is available. If in doubt, use a tape measure to verify available airflow clearance.

- a). Put on an ESD protective wrist strap.
- b). Remove the MC180A from its packaging. You may wish to note the serial number before installing the unit.
- c). Grasp the MC180A by its side and orient it so that the front panel lettering is upright. Align the MC180A, then slide it into the rack.
- d). Turn the front panel screws provided in the installation kit and tighten the MC180A securely into place. Do not over tighten the screws.
- e). Inspect the alignment of the finished installation, and adjust if needed. If no problems are found, rack installation is complete.

3.6 MC180A unit address

 **Note:** Some MC180A configurations may not support this feature. Refer to Appendix A to determine if your model includes a rotary switch for addressing.

Each MC180A includes one multi-carrier power amplifier (MCPA) module. Each individual MCPA module may be configured with a unique address for identification through the RS-485 port. The four addresses available are 0,1,2, and 3.

- a). Locate the rotary switch on the rear of the MC180A.
- b). Set the switch to the desired address: 0,1,2, or 3.

 **Note:** There are 10 switch settings on the rotary switch. Use only switch settings 0, 1, 2 or 3. Use of switch settings 4, 5, 6, 7, 8 or 9 will result in an undetermined address, and is not advised.

3.7 Supplied DC voltage

The customer supplied DC input voltage cabling must be sized to the correct wire gauge to accommodate the wire length and the DC current requirements of the MC180A. Refer to Appendix A for further details regarding maximum current and DC receptacle information.

3.8 Ground Wire Installation

- a). Locate the chassis ground stud on the rear of the MC180A for ground wire attachment. Isometric diagrams are depicted in Appendix A, and may help in locating this connector.
- b). Measure the distance and routing between the MC180A ground stud and an attachment point to earth ground. Cut a length of #8 AWG insulated (green) solid copper wire sufficient for the connection.
- c). Crimp a circular lug to one end of the ground wire.
- d). Remove the nut and lock washer on the MC180A ground stud. Attach the DC ground wire lug to the grounding stud on the MC180A, and replace the lock washer and nut. Tighten the nut securely.
- e). Use a VOM to verify that the resistance between the chassis ground and true earth ground is less than 100 Ohms.
- f). Inspect the finished connection. If no problems are discovered, ground wire installation is complete.

3.9 DC voltage wire installation

 **WARNING: Do not perform DC lead installation with energized leads.**

3.9.1 AMP Mate N Lok DC Voltage Receptacle

Note: For configurations which use an AMP Mate N Lok DC input receptacle, a mating DC voltage plug and crimp on pins are provided in an installation kit with the MC180A. A DC mating power cord is also available to order.

- a). Locate the DC voltage receptacle on the rear of the MC180A. Refer to Appendix A for diagrams and labeling to help locate this receptacle. Inspect the receptacle for pin damage or irregularity before proceeding.
- b). Locate the positive and negative terminals on the customer-provided DC power source, and verify polarity with a VOM.

 **WARNING: Do not reverse the polarity of DC supply leads. A reversed-polarity connection will severely damage the MC180A and will void the product warranty.**

- c). Measure the distance and routing between the power source and the MC180A DC receptacle. Cut equal lengths of wire. Refer to the specifications in Appendix A for details about current requirements and wire AWG.
- d). Crimp pins to the wires, and insert the pins into the AMP Mate N Lok plug.
- e). If lugs or other connectors are required at the supply end of the DC leads, attach them prior to connecting to the DC power source.
- f). Verify polarity, and plug in the 9-pin AMP Mate N Lok connector.

3.10 RF cabling

 **WARNING: Do not perform RF cable installation with energized cables. Disconnect all RF feeds before handling RF cables.**

 **Important: The integrity of RF cabling is critical to the electrical performance of the MC180A.**

3.10.1 Input RF cable installation

The MC180A provides a connector (J1) for RF input. Connection to the MC180A is achieved using an operator-supplied coaxial cable terminated with a male type-N connector.

- a). Locate the male input RF connector on the end of the coaxial cable from the RF signal source. (Some configurations may have multiple source coaxial cables). Inspect the connector for damage or irregularity, and fix any problems with the cable or connector before proceeding.
- b). Clean the male connector with spray-on contact cleaner, as needed.
- c). Locate the female connector (J1) on the MC180A. Refer to diagrams and labeling in Appendix A for help in locating the connector.
- d). Screw the male cable connector firmly onto the MC180A female connector.

3.10.2 Output RF cable installation

The MC180A includes a female connector (J2) for amplified RF output. Connection to the MC180A is accomplished via a customer supplied coaxial cable terminated with a male connector.

- a). Locate the male RF output connector on the end of the coaxial cable attached to the output load. Inspect the connector for damage or irregularity and fix any problems with the cable or connector before proceeding.
- b). Clean the male connector with spray-on contact cleaner, as needed.
- c). Locate the female RF output connector (J2) on the MC180A. Refer to Appendix A for connector location and labeling.
- d). Screw the male cable connector firmly into the female RF output connector of the MC180A.

3.11 Customer interface

3.11.1 RS-485 / Alarm interface cable installation

The MC180A provides a 15-pin miniature sub-D female connector (J3) for RS485 communications and alarm output to the customer system. Connection to the MC180A RS485 and alarm connector is achieved using a customer supplied multi-conductor shielded cable, terminated with a 15-pin miniature sub-D male plug. Refer to Appendix A for location and pin out of the RS-485/alarm port.

- a). Locate the male 15-pin sub-D connector on the end of the alarm/control interface cable from the site alarm monitoring system. Inspect the connector for damage or irregularity and remedy any problems with the cable or connector before proceeding.
- b). Clean the male connector with spray-on contact cleaner.
- c). Locate the female 15-pin sub-D RS485/Alarm connector (J3) on the MC180A. Refer to Appendix A for connector location and labeling.
- d). Connect the male 15-pin sub-D connector to the female 15-pin sub-D connector mounted on the MC180A. Tighten the two screws on the cable connector firmly.

 **Note:** When daisyshaining more than one MC180A in an installation, make sure that all DB15 connections in the daisy chain are terminated. Lack of termination will disrupt the continuity of the chain and will not allow communication with down link units.

3.11.2 Summary Alarm output interface cable installation

 **Note:** Some MC180A configurations may not support this feature. Refer to Appendix A to determine if your model includes a Buchanan connector for alarm output.

A 10 terminal Buchanan connector is provided on some configurations of the MC180A for dry contact alarm outputs. With this configuration, individual wires may be attached to the terminals with a screwdriver. Refer to Appendix A for availability, location and pin out of this alarm output connector.

 **Note:** On models where this feature is available, the factory configuration is for Normally closed contacts. Upon alarm condition the relay opens and continuity is broken between wire pairs. For normally open configurations please contact factory personnel at time of order to request a special configuration.

- a). Locate the individual wire pairs dedicated to alarm reporting interface to your site. Inspect for damage or irregularity and remedy any problems before proceeding.
- b). Using a flat blade screw driver insert each wire of the pair into the Buchanan connector. Refer to Appendix A for connector location, labeling and pin out.
- c). Tighten the attachment screws on the connector firmly.

Chapter 4

Operation

4.1 Introduction

This chapter provides detailed step-by-step instructions to verify that an installed MC180A is operating and is ready to be placed into service. The instructions provide an ordered list of tasks and a description of the expected results. Installation verification checks should be performed following installation of the MC180A and after major maintenance or repairs have been completed.



Important: The MC180A should be only operated by trained and qualified personnel. Always follow safety warnings.



Note: Before shipment, the MC180A was inspected and found free of mechanical and electrical defects. The electrical performance of the MC180A should be verified using these procedures. If there is any deficiency, or if electrical performance is not within specifications, notify your Spectrian representative immediately.

4.2 Safety Information

To avoid injury, installers, technicians, and maintenance personnel must follow Spectrian's recommended procedures and observe safety precautions.



Warning: Persons with cardiac pacemakers should avoid exposure to RF radiating elements.



Warning: Exposing the human eye to high levels of radio-frequency radiation may result in the formation of cataracts. Do not operate exposed circuitry or radiating elements with personnel in close proximity to the radiating source. Always replace covers and shields during operation.

4.3 Tools

The following tools are recommended to perform installation tasks.

Tools:

- HP 436 Power meter
- Volt-Ohmmeter (VOM)

4.4 Start up and verification

Before operating the MC180A, verify proper installation and assembly as described in Chapter 3. Prepare for operation by assuring that the DC power supply at the site is functioning normally and that the MC180A is physically connected to an input RF signal source and terminated in an output load. After mechanical and electrical installation tasks are complete, the MC180A is ready for power-on check.



Important: Read and understand the following steps before taking any action.



WARNING: The RF output of the MC180A should be connected to a 50-ohm load before DC power is turned on. If a dummy load is used, it must be capable of dissipating at least 45 watt average power and 450 watts of peak power.

- a). Switch on or connect DC input voltage to the MC180A. When powered-on, the MC180A should respond by:
 - Fault & power LEDs register red for 1 second
 - Fault & power LEDs toggle red/green for 5 seconds.
 - Fault & power LEDs register current status. If no faults are present, the Power LED will register a steady green indicating that the unit is functional.
- b). To disable the unit either activate the disable command through the RS 485 interface; or disable the unit by shorting pins 7 and 8 of the Buchanon screw terminal connector; or provide a momentary short of pin 6 of the DB15 connector to GND.
- c). After the unit is enabled, allow 5 minutes for the MC180A to reach a stable operating temperature before attempting to apply

commercial traffic signal power. During this warm-up period all LED indicators should display green.

 **Note: Verify that there are no obstructions to airflow in the front or rear of the MC180A.**

- d). Verify the MC180A address on the rear panel is set correctly for the RS-485 serial control interface. Refer to Section 3.6 for addressing instructions and precautions.

Note: This feature is not available in all configurations.

 **Note: If the MC180A is operated without RS-485 interface to a computer, it must be enabled by a low to high (5VDC) transition on the ENABLE line to operate.**

- e). Observe the LED indicators on the MC180A. All indicators should remain green.

If the MC180A is connected to a remote operations center via the RS-485 interface connector (J3) or if alarm interface connectors (J4) are used, verify no alarms have been reported.

- f). If LED indicators display amber, red, or flashing red, a problem exists or the unit is disabled and remedial action must be taken. Refer to Appendix A for a information about alarms. Refer to Chapter 6, Diagnosis and Repair for assistance. If no problems are encountered, apply RF drive power as described below.
- g). Prior to applying RF input power to the MC180A, verify that the applied RF input power for a single channel and the sum of all channels is below the maximum rated RF input power.

 **Note: If the MC180A has the Buchanan alarm interface (J4), the unit may be disabled by installing a short wire between terminals 7 and 8. Once disabled, removal of the short will enable the unit. Refer to Appendix A to determine if your model includes the Buchanan connector.**

 **Note: Prior to keying on individual channels determine the power of each channel, including the input drive level and output power needed.**

- h). At the customer provided host system exciter, switch on or connect the RF input drive power. Refer to the instructions supplied with your RF source equipment.

 **Note: It is preferred that RF input power be applied after DC voltage is applied.**

- i). After connecting the RF input line, key-on each channel individually. Monitor the RF input and output using a HP436A or equivalent power meter. Verify that the maximum input and output power is not exceeded. Key off the channel and repeat for the remaining channels. Continue to verify the needed power is not exceeded.
- j). After verifying the power of each channels individually, key on the channels one at a time and continue to monitor output power. If the output exceeds 30 watts average output power, readjust all channels as necessary to ensure average output power remains less than or equal to 30 watts.

Chapter 5

Diagnosis and Replacement

5.1 Introduction

This chapter provides basic information about diagnosis of problems with the MC180A. Diagnostic information available from LED fault indicators and alarm codes are described. Tables of fault indications and alarms are provided in Appendix A. Please read the following safety information prior to beginning diagnosis and repair actions.



Important: Troubleshooting and repairs should be performed only by trained and qualified personnel or at authorized Spectrian repair depots. Observe all safety warnings and use the required safety equipment when performing the tasks described in this chapter.

5.2 Safety Information

To avoid injury, installers, technicians, and maintenance personnel must follow Spectrian's recommended procedures and observe all safety precautions. The MC180A transmits high power at radio frequencies. Severe radiation burns can occur if recommended safety precautions are not strictly observed.



Warning: Persons with cardiac pacemakers should avoid exposure to RF radiating elements.



Warning: Exposing the human eye to high levels of radio-frequency radiation may result in the formation of cataracts. Do not operate exposed circuitry or radiating elements with personnel in close proximity to the radiating source. Always replace covers and shields during operation.

Except where specifically indicated, always **disconnect** RF input power (J1) and DC voltage (J5) to the MC180A before performing procedures that do not require power. For those procedures that do require power, be extremely cautious in handling test leads, tools,

and equipment near live circuits. Never reach into an enclosure for the purpose of servicing or adjusting except in the presence of a person who can render aid.

5.3 Fault status

5.3.1 Fault management

Fault management may be accomplished by various means with the MC180A. The MC180A includes summary alarm LEDs, as well an RS485 compatible status/alarm interface. Some configurations offer an additional RS485 connector for daisy chaining (for units used in multi-sectored sites), or an optional Buchanan connector for screw-driver terminal connection to alarm outputs. Refer to Appendix A for the alarm reporting features of your particular configuration.

Each MC180A includes a pair of visual fault management indicators. These LEDs may be used for visual diagnostics by on-site technicians.

A Buchanan connector may be provided to allow dry socket contact connection to the alarm output. Refer to Appendix A.

In addition to the above alarm reporting, the MC180A features an RS485 interface to allow status and alarm polling from a remote operations and maintenance center. Operators may receive module-level status and fault information through alarm codes transmitted over a RS 485 bus.

5.3.2 Fault classification

The MC180A fault management subsystem classifies faults into three categories. In order of escalation, these are:

- **Minor fault.** A minor problem exists, but the fault does not require a module to be taken out of service. Routine service attention is recommended.
- **Major fault.** A major problem exists such that the MC180A no longer meets performance specifications. The unit is not automatically disabled. Urgent service attention is required.

- **Out-of-service fault.** A major failure or a condition that could result in damage has taken the MC180A out of service. Immediate service attention is required.

5.3.3 Responses to faults

The fault management system automatically responds when a fault is detected. Responses vary in impact from alarm notification with no subsequent action (for minor faults) to alarm notification and shut-down (for out-of-service faults). The hierarchy of responses is designed to keep the MC180A in operation unless continued operation would result in damage to the unit. Under some fault conditions, the MC180A continues to operate in a degraded state. The operator may choose to continue to operate in a degraded state, shed channels, or shut down the MC180A until repairs can be completed.

5.3.4 Automatic fault resets

To minimize false alarms from transient anomalies, the fault management system is designed with built-in hysteresis. If the fault condition persists past the hysteresis interval, the appropriate fault alarm is set.

When a major fault is detected, the MC180A attempts to clear the fault by performing a reset. In most cases, the MC180A will attempt to reset three times. If the alarm condition fails to clear after three attempts, the MC180A remains in operation with the fault alarm set.

When an out-of-service fault occurs, the MC180A will automatically be taken off-line by the Fault Manager. If the MC180A is taken out of service because of an out-of-service fault, operator intervention is required to bring the MC180A on-line again.

In the case of an over-temperature major alarm, the fault manager will attempt to clear the alarm one time only by resetting. If the fault condition does not clear, the alarm classification will escalate to out-of-service, and the MC180A will shut down and remain off-line until returned to service by the operator.

5.3.5 Manual fault resets

When a major fault is detected the operator may choose from the following options:

- Take no action and allow the MC180A to operate in a degraded state until service can be performed.
- Load shed channels to reduce the power to the MC180A.
- Issue a disable-amplifier command through the RS-485 interface to remove the MC180A from service.
- Disable the amplifier via the Buchanan connector, if this feature is included on your model. (Refer to Appendix A.)
- Attempt to reset the MC-180A manually by connecting +5VDC to the alarms reset J4 pin 6.
- Issue an enable-amplifier command through the RS-485 interface, testing an assumption that a false alarm has occurred, and wait to see if the fault alarm returns. This action is not recommended by Spectrian.

 **Note: The last option involves risk to the MC180A. Re-enabling an off-line MC180A without determining the cause of the fault could result in damage.**

5.4 LED indicators

Each MC180A module is equipped with two LED indicators mounted on the front panel. These indicators provide useful status and diagnostic information to operators and technicians.

	Power		Fault	
	Status OK	alarm	normal	alarm
LED	green	red	green	amber/red

5.5 Using LED Indicators to diagnose and remedy faults

Under start-up conditions, the LED indicators will flash different colors, as indicated in section 4.4. After a period of approximately six seconds, both LEDs should light steady green to indicate that no fault condition exists (in the enabled mode). If the Power LED is flashing amber, the unit is operational with no fault conditions and is awaiting an enable command. If both LEDs are green and the MC180A does not seem to be operating, check to ensure that enable line is correctly set, and RF input is applied. The MC180A will draw three (3) to four (4) Amps of quiescent current if the unit is not enabled (Power LED flashing amber). If the unit is enabled, but no RF input is being amplified, the current draw should increase to roughly ten (10) Amps.

Under normal enabled operating conditions, both LED indicators will display green.

In the event a Major or Out-of-Service fault condition exists, the FAULT LED indicator will display red or flashing red to identify a problem with the unit. In the event of a failed fan, a Minor alarm condition, the FAULT LED will light amber.

If the fault is a Major or Minor fault, both POWER LEDs will remain green, indicating the unit is still in service. If the fault is an Out-of-Service fault, the POWER LED will light red or flashing red.

Refer to Appendix A for a quick reference Fault Troubleshooting Guide.

5.6 Using status codes to diagnose and remedy faults

The MC180A provides an RS-485 serial interface to transmit status codes to a remote host computer and receive a limited set of commands from the host. The RS-485 protocol requires that the remote host poll each attached MC180A. The RS-485 interface allows multi-drop attachment which permits up to four MC180As to communicate with the host over a single bus. Some configurations of MC180A support configurable device addresses through a rotary switch located on the rear panel. Refer to Appendix A to determine if your configuration supports this addressing feature.

To receive status information from attached MC180As, the remote host must regularly query each MC180A. A three byte status message is returned in response to each query. The network management program must retrieve and display this information in a way that provides the most useful information to an operator. For

more information on the byte sequencing and error flag protocol please consult the factory.

 **Note:** The MC180A fault management system and its associated alarms and fault indicators operate independently of the RS-485 interface.

5.7 MC180A replacement

 **Caution:** Turn off the DC voltage and RF power prior to replacing a MC180A. Remove all DC and RF connectors prior to removing the MC180A from the rack.

- a). If the MC180A is rack mounted, first remove the front panel retaining screws. Grasp the front panel with both hands and pull the MC180A straight out from the rack. The MC180A is heavy! Take care that it does not drop or swing into personnel or equipment.
- b). Set the disconnected MC180A aside in a clean, safe place, free of electrostatic charges.
- c). Remove the replacement MC180A from its static-protective packaging. You may wish to note the serial number on your repair record before installing the module.
- d). Follow the installation instructions in Chapter 3, Section 3.5.
- e). Follow the operation instructions in Chapter 4, Section 4.3.

APPENDIX A

Configuration Information

Major specifications for the MC180A-045-004

Electrical specifications @ 25 C:

Specifications

Frequency range	869-894 MHz
Average Power Output into 50 ohms	30W min. out at connector (J2)
Output Phase delta (rel. to AMT std)	+/- 10 degrees
Power Output Stability for single frequency	+/- 1 dB under normal operating conditions
Intermodulation distortion (864-899 MHz)	-70 dBc typ.
	-65 dBc Min., under normal operating conditions
Intermodulation distortion (824-864 MHz)	-60 dBc Min., under normal operating conditions
Gain	45 dB min., 48 dB max.
Output Protection	Mismatch protected with isolator
Power Input	Any number of carriers, as limited only by composite output power specification and ≤ -76 dBc input IMD product with a ≤ 7 dB peak to ave. max with random phasing of input signals.
Dynamic Channel Allocation support	Any spacing from 30 KHz to 25 MHz
Input/Output Port Return Loss	-15 dB Min. for full spec performance
Second Harmonic Output	≤ -35 dBc
Third and greater harmonics	≤ -65 dBc
Spurious and broadband noise	-60 dBc/30 Khz BW (824 Mhz to 894MHz)
Duty Cycle	Continuous
Maximum tone spacing	25 MHz
Minimum tone spacing	30 KHz

Supplemental characteristics:

Connectors	<ol style="list-style-type: none"> 1. RF input (J1): SMA (F) type on rear panel 2. RF output (J2): N type (F) on rear panel 3. Summary Alarms Output (J3): RS-485/alarms output on DB-15 (F) on rear panel 4. DC inputs (J5) : 9 pin Amp Mate Lock on rear panel 5. Alarms summary dry contacts (J4): 10 position Buchanan connector with captive terminal screws
Indicators	<ol style="list-style-type: none"> 1. Two LED indicators - front panel Power - Green/Red/Amber Fault - Green/Red/Amber
Protection	<ol style="list-style-type: none"> 1. Gross input overdrive 2. Excessive temperature 3. Auto Reset after recoverable alarms
DC Input voltage range	21 to 31 Vdc
DC input current	23A max. @ 26Vdc; 29 A max. @ 21Vdc, 20A max. @ 31V
DC inrush current	39 A max , 100 msec.
Cooling	Air cooled with internal fans
Package	19" (483mm) rackmount enclosure
Operating temperature	0° to +50° C
Operating Humidity	5 to 95% non-condensing
Storage temperature	-50° to +85° C
Front panel finish	Paint: Pantone cool grey 3C
Size (LW)	17" x 19" (431mm x 483mm) Max.
Vertical Panel height	3 RU (rack units), 5.25" (133mm)
Weight	40 lbs. (18 Kg) Typ.
Shipping weight	<math><60</math> lbs (27 Kg) Typ

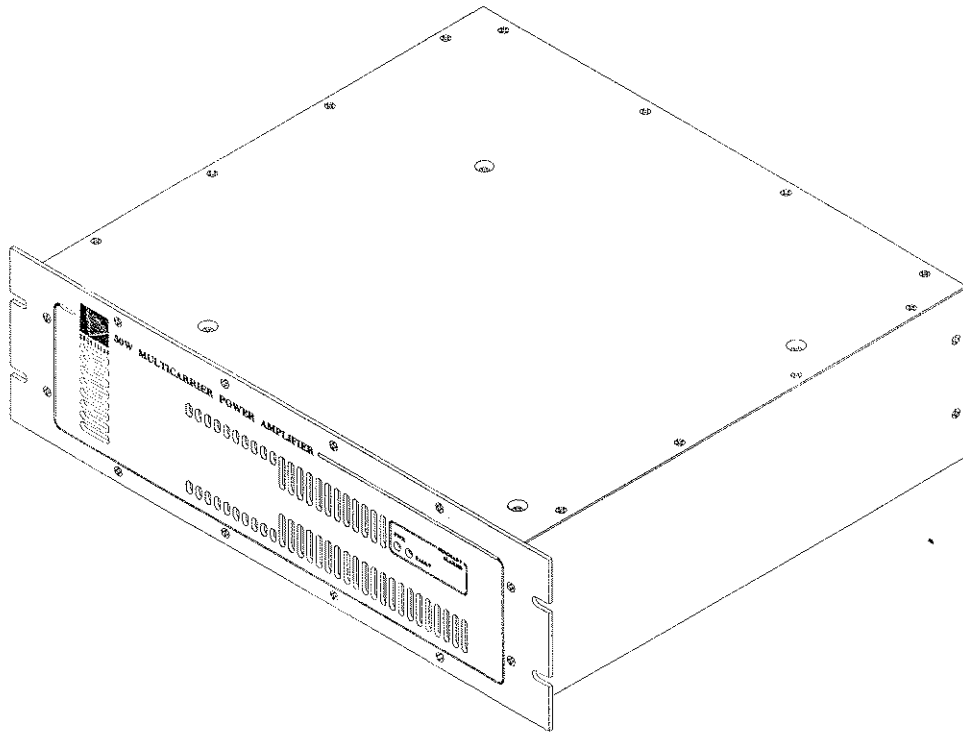

MC180A-045-004 Amplifier (front isometric).

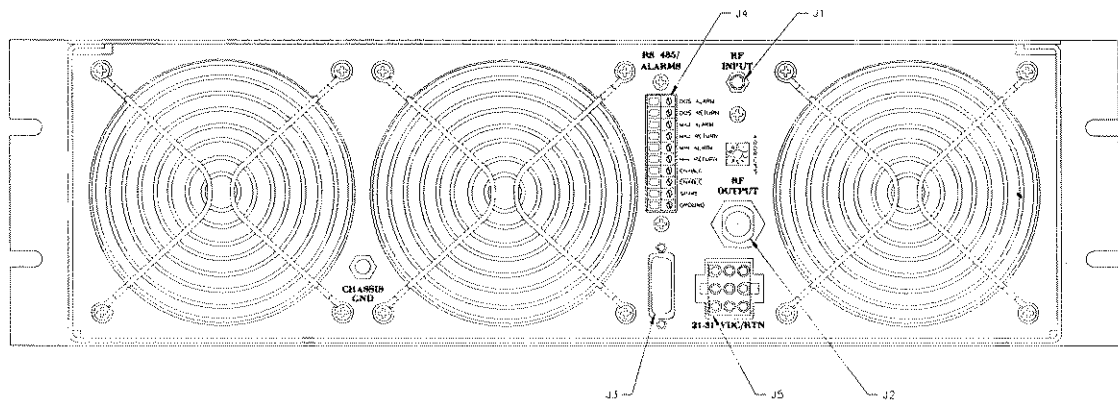

MC180A-045-004 Amplifier (rear).

MC180A-045-004 connector position pin-out

Connector Number: J3
Connector Location: Rear panel
Labeled: RS 485/Alarms
Pin: 15-pin connector
Connector Mfg P/N: Amphenol p/n 17D-A-15-S

Uses 22AWG wire, typically.

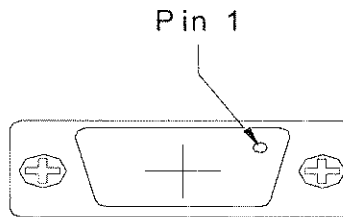

View of 15-pin miniature sub-D (J3)

Pin	Description	Connector																
1	Reserved	<table border="1"> <tr> <td>8</td><td>7</td><td>6</td><td>5</td><td>4</td><td>3</td><td>2</td><td>1</td> </tr> <tr> <td></td><td>15</td><td>14</td><td>13</td><td>12</td><td>11</td><td>10</td><td>9</td> </tr> </table>	8	7	6	5	4	3	2	1		15	14	13	12	11	10	9
8	7		6	5	4	3	2	1										
	15	14	13	12	11	10	9											
2	Reserved																	
3	Reference Ground																	
4	Reserved																	
5	not used																	
6	Amplifier Enable / Reset																	
7	not used																	
8	Earth Ground/ Cable shield ground																	
9	RS-485A in																	
10	RS-485B in																	
11	Reference Ground																	
12	not used																	
13	not used																	
14	RS-485A out (for daisy chain)																	
15	RS-485B out (for daisy chain)																	

Connector Number: J4
Connector Location: Rear panel
Labeled: Not labeled
Pin: 10-position
Connector Mfg P/N: Buchanan

Uses 22AWG wire, typically.

Pin	Description	Connector
-----	-------------	-----------

1	OOS alarm
2	OOS return
3	Major alarm
4	Major return
5	Minor alarm
6	Minor return
7	<u>Enable</u>
8	<u>Enable/Gnd</u>
9	not used
10	Digital ground

1	2	3	4	5	6	7	8	9	10
---	---	---	---	---	---	---	---	---	----

Connector Number: J1
Connector Location: Rear panel
Labeled: RF Input
Connector Mfg P/N: SMA (f)

Pin Description

1 Input RF type-N connector

Connector Number: J2
Connector Location: Rear panel
Labeled: RF Output
Connector Mfg P/N: Type N (f)

Pin Description

1 Output RF type "N" connector

Connector Number: Not numbered
Connector Location: Rear panel
Labeled: Chassis Ground
Connector Mfg P/N: 1/4-20 PEM threaded stud

Pin Description

1 Threaded ground stud

Connector Number: J5
Connector Location: Rear panel
Labeled: 21-31 VDC/RTN
Pin: 9-pin
Connector Mfg P/N: AMP Mate N Lok p/n 1-480-707-0
Mating Connector P/N: AMP Mate N Lok p/n 1-480-706-0

Uses 14 AWG wire, typically.

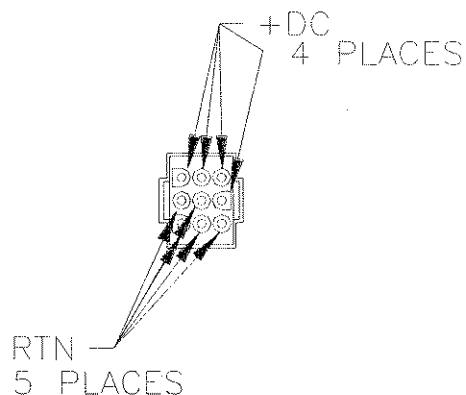

View of Mate-N-Lok connector on MC180A rear panel

Pin	Description	Connector									
1	+21 to +31 VDC	<table border="1"> <tr> <td>1</td> <td>2</td> <td>3</td> </tr> <tr> <td>4</td> <td>5</td> <td>6</td> </tr> <tr> <td>7</td> <td>8</td> <td>9</td> </tr> </table>	1	2	3	4	5	6	7	8	9
1	2		3								
4	5		6								
7	8		9								
2	+21 to +31 VDC										
3	+21 to +31 VDC										
4	DC return										
5	DC return										
6	+21 to +31 VDC										
7	DC return										
8	DC return										
9	DC return										

MC180A-045-004 FAULT INDICATORS

Alarm Description	Alarm Class	LED		Reply Byte		Amplifier Response
		Power	Fault	Class	Type	
Self test Fail	Critical	Red	Red			MCPA cannot operate
Warm up	None	Green/ Red alternating	Green/ Red alternating			MCPA is warming up and getting ready for operation.
Unit Disabled	None	Amber flash	Green			Requires RS485 enable command or Buchanan connector steady short on pins 7 and 8.
Unit Disabled/Out of service Fault	None	Amber flash	Red			Requires RS485 enable command or Buchanan connector or steady short on pins 7 and 8.
Unit Disabled/Major fault	None	Amber flash	Red			Requires RS485 enable command or Buchanan connector steady short on pins 7 and 8.
Fan Failure	Minor	Green	Amber	ustat 1 B5	ustat0 B6	MCPA remains operational.
High Temperature	Major	Green	Red	ustat 1 B6	ustat0 B3	MCPA has reached a cautionary temperature. MCPA remains operational.
PA Internal Voltage	Major	Green	Red	ustat 1 B6	ustat1 B2	MCPA remains operational. Continued excessive deviation will result in correction fault.
Gain Degradation	Major	Green	Red	ustat 1 B6	ustat0 B7	MCPA remains operational.
PCM	Major	Green	Red Flash	ustat 1 B6	ustat0 B4 or B5	Voltage from PCM is not within 26 +/- 0.5 VDC. MCPA remains operational.
Load VSWR	Major	Green	Red Flash	ustat 1 B6	ustat1 B4	MCPA remains operational.

PCM	Out of Service	Red Flash	Red Flash	ustat 1 B7	ustat0 B4 or B5	Voltage from PCM is beyond safe operating points. MCPA is shut off.
RF Overdrive	Out of Service	Red Flash	Red Flash	ustat 1 B7	ustat1 B2	MCPA is shut off.
High Temperature	Out of Service	Red	Red	ustat 1 B7	ustat0 B3	MCPA has reached a dangerous temperature. MCPA is shut off.
Correction	Out of Service	Red	Red	ustat 1 B7	ustat1 B3	MCPA is shut off.

MC180A Troubleshooting Guide

POWER LED	FAULT LED	FAULT CONDITION	FAULT CLAS	REMEDIAL ACTION
Green	Green	Normal operation.		
Amber	Green	Unit Disabled.	None	Requires RS485 enable command or Buchanan connector steady short pins 7 and 8.
Green	Amber	MCPA fan failure.	Minor	Possible Fan Failure. Contact Spectrian for repair.
Green	Red (flashing)	Internal Voltage out of range. Load VSWR fault.	Major	1) Check DC input voltage and adjust to specified range. 2) Check VSWR of load, adjust if required. 3) Possible MCPA failure. Contact Spectrian for repair.
Green	Red	High temperature. Internal voltage fault. Gain degradation.	Major	Possible MCPA Failure. Contact Spectrian for repair.
Red (flashing)	Red (flashing)	Internal Voltage outside limits. MCPA RF overdrive.	Out-of-service	1) Check DC input voltage and adjust to specified range. 2) Check RF input to amplifier, adjust if required. 3) Possible MCPA failure. Contact Spectrian for repair.
Red	Red	Temperature over limit. Correction failure.	Out-of-service	Possible MCPA Failure. Contact Spectrian for repair.

###

Major specifications for the MC180A-045-004

Electrical specifications @ 25 C:

Specifications

Frequency range	869-894 MHz
Average Power Output into 50 ohms	30W min. out at connector (J2)
Output Phase delta (rel. to AMT std)	+/- 10 degrees
Power Output Stability for single frequency	+/- 1 dB under normal operating conditions
Intermodulation distortion (864-899 MHz)	-70 dBc typ.
	-65 dBc Min., under normal operating conditions
Intermodulation distortion (824-864 MHz)	-60 dBc Min., under normal operating conditions
Gain	45 dB min., 48 dB max.
Output Protection	Mismatch protected with isolator
Power Input	Any number of carriers, as limited only by composite output power specification and ≤ -76 dBc input IMD product with a ≤ 7 dB peak to ave. max with random phasing of input signals.
Dynamic Channel Allocation support	Any spacing from 30 KHz to 25 MHz
Input/Output Port Return Loss	-15 dB Min. for full spec performance
Second Harmonic Output	≤ -35 dBc
Third and greater harmonics	≤ -65 dBc
Spurious and broadband noise	-60 dBc/30 Khz BW (824 Mhz to 894MHz)
Duty Cycle	Continuous
Maximum tone spacing	25 MHz
Minimum tone spacing	30 KHz

Supplemental characteristics:

Connectors	<ol style="list-style-type: none"> 1. RF input (J1): SMA (F) type on rear panel 2. RF output (J2): N type (F) on rear panel 3. Summary Alarms Output (J3): RS-485/alarms output on DB-15 (F) on rear panel 4. DC inputs (J5) : 9 pin Amp Mate Lock on rear panel 5. Alarms summary dry contacts (J4): 10 position Buchanan connector with captive terminal screws
Indicators	<ol style="list-style-type: none"> 1. Two LED indicators - front panel Power - Green/Red/Amber Fault - Green/Red/Amber
Protection	<ol style="list-style-type: none"> 1. Gross input overdrive 2. Excessive temperature 3. Auto Reset after recoverable alarms
DC Input voltage range	21 to 31 Vdc
DC input current	23A max. @ 26Vdc; 29 A max. @ 21Vdc, 20A max. @ 31V
DC inrush current	39 A max , 100 msec.
Cooling	Air cooled with internal fans
Package	19" (483mm) rackmount enclosure
Operating temperature	0° to +50° C
Operating Humidity	5 to 95% non-condensing
Storage temperature	-50° to +85° C
Front panel finish	Paint: Pantone cool grey 3C
Size (LW)	17" x 19" (431mm x 483mm) Max.
Vertical Panel height	3 RU (rack units), 5.25" (133mm)
Weight	40 lbs. (18 Kg) Typ.
Shipping weight	<math>< 60</math> lbs (27 Kg) Typ

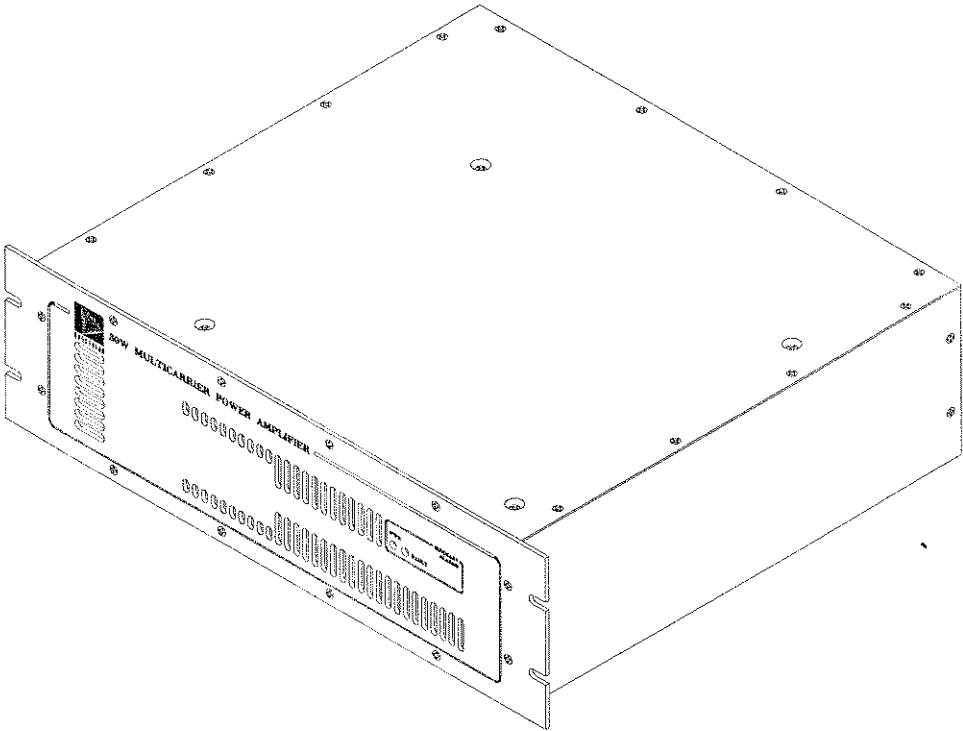

MC180A-045-004 Amplifier (front isometric).

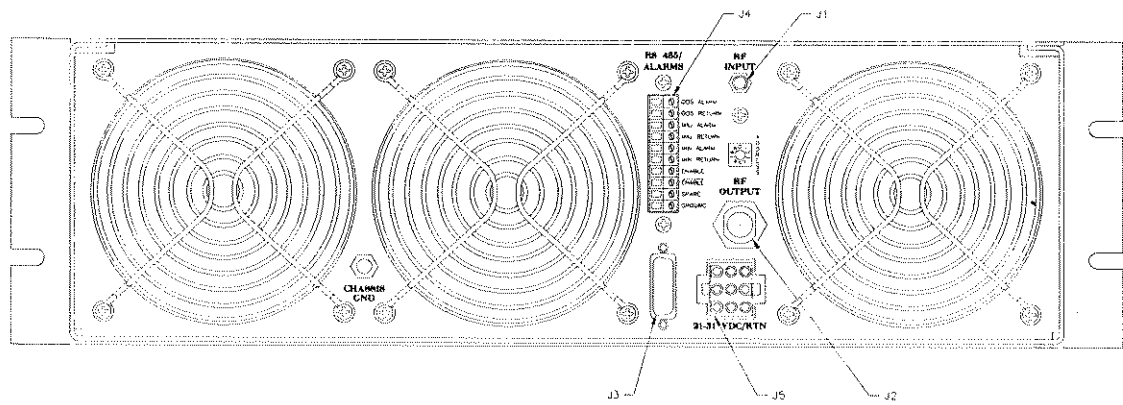

MC180A-045-004 Amplifier (rear).

